

## Christie Digital MicroTiles Various 4:3 & 16:9 Aspect Ratio Wall Layouts

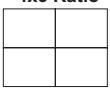

**\*Modular, Stackable, Configurable  
High Res Videowall Cubes**

**4x3 Ratio**  
**2.68'(w) x 2.01'(h)**  
 TILES: 2 x 2 (4)  
 WEIGHT: 81.2 LBS  
 POWER: 4.8 Amps Max  
 PIXELS: 1,440 x 1,080



**16x9 Ratio**  
**4.02'(w) x 2.01'(h)**  
 TILES: 3 x 2 (6)  
 WEIGHT: 121.8 LBS  
 POWER: 7.08 Amps Max  
 PIXELS: 2,160 x 1,080

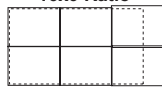

**4x3 Ratio**  
**4.02'(w) x 3.01'(h)**  
 TILES: 3 x 3 (9)  
 WEIGHT: 182.7 LBS  
 POWER: 10.8 Amps Max  
 PIXELS: 2,160 x 1,620

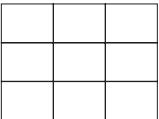

**16x9 Ratio**  
**5.35'(w) x 3.01'(h)**  
 TILES: 4 x 3 (12)  
 WEIGHT: 243.6 LBS  
 POWER: 14.16 Amps Max  
 PIXELS: 2,880 x 1,620

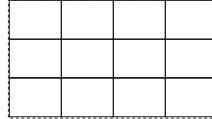

**4x3 Ratio**  
**5.35'(w) x 4.02'(h)**  
 TILES: 4 x 4 (16)  
 WEIGHT: 324.8 LBS  
 POWER: 19.2 Amps Max  
 PIXELS: 2,880 x 2,160

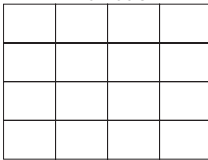

**16x9 Ratio**  
**6.7'(w) x 4.02'(h)**  
 TILES: 5 x 4 (20)  
 WEIGHT: 406 LBS  
 POWER: 23.6 Amps Max  
 PIXELS: 3,600 x 2,160

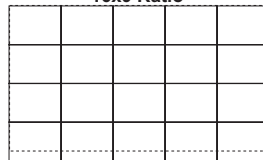

**SINGLE TILE SPECIFICATIONS**

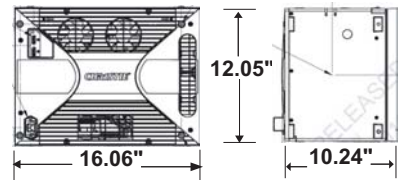

PIXELS: 720 (w) x 540 (h)  
 WEIGHT: 20.3 LBS  
 BRIGHTNESS: 800 NITS  
 POWER: AVG 1Amps / MAX 1.18Amps

**4x3 Ratio**  
**6.7'(w) x 5.02'(h)**  
 TILES: 5 x 5 (25)  
 WEIGHT: 507.5 LBS  
 POWER: 30 Amps Max  
 PIXELS: 3,600 x 2,700

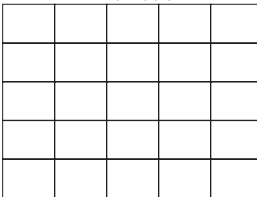

**16x9 Ratio**  
**8.03'(w) x 4.02'(h)**  
 TILES: 6 x 4 (24)  
 WEIGHT: 487 LBS  
 POWER: 28.32Amps Max  
 PIXELS: 4,320 x 2,160

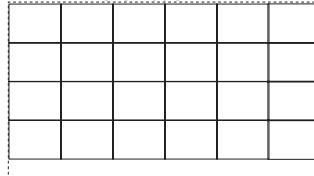

**4x3 Ratio**  
**8.03'(w) x 6.03'(h)**  
 TILES: 6 x 6 (36)  
 WEIGHT: 730.8 LBS  
 POWER: 43.2 Amps Max  
 PIXELS: 4,320 x 3,240

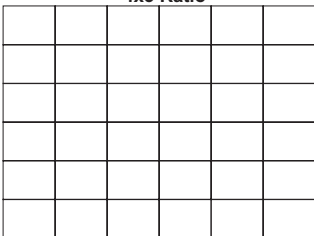

**16x9 Ratio**  
**9.37'(w) x 5.02'(h)**  
 TILES: 7 x 5 (35)  
 WEIGHT: 710.5 LBS  
 POWER: 41.3 Amps Max  
 PIXELS: 5,040 x 2,700

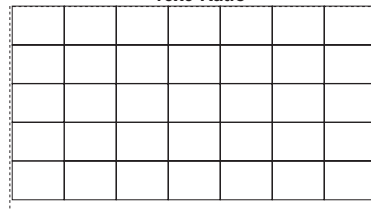

**4x3 Ratio**  
**9.37'(w) x 7.03'(h)**  
 TILES: 7 x 7 (49)  
 WEIGHT: 994.7 LBS  
 POWER: 58.8 Amps Max  
 PIXELS: 5,040 x 3,780

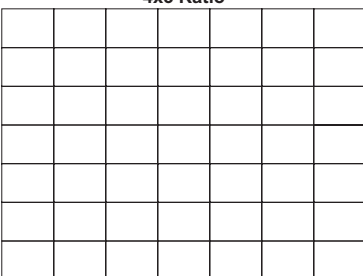

**16x9 Ratio**  
**10.71'(w) x 6.03'(h)**  
 TILES: 8 x 6 (48)  
 WEIGHT: 974.4 LBS  
 POWER: 56.64 Amps Max  
 PIXELS: 5,760 x 3,840

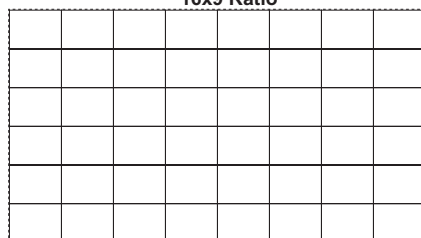

\*Ground Support feet on bottom row of MicroTiles will add approx. 1" to height of display

\*Other wall sizes available - Please call for custom wall configurations



## Christie Digital MicroTiles Various Custom Aspect Ratio Wall Layouts

**\*Modular, Stackable, Configurable  
High Res Videowall Cubes**

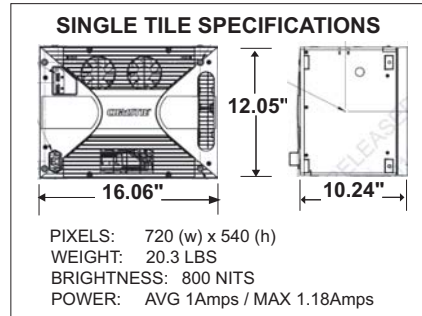
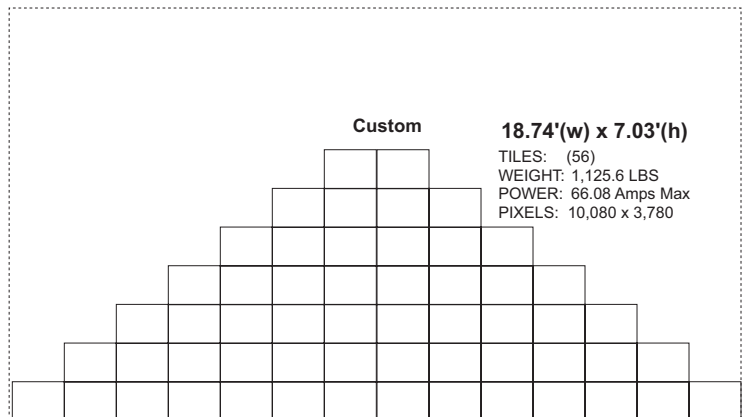
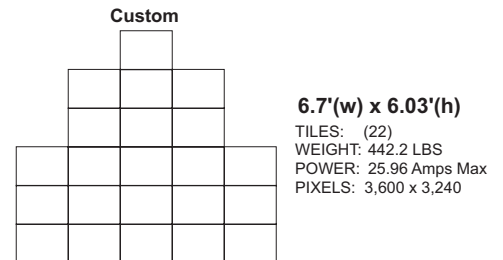
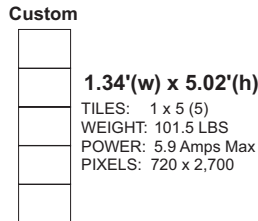
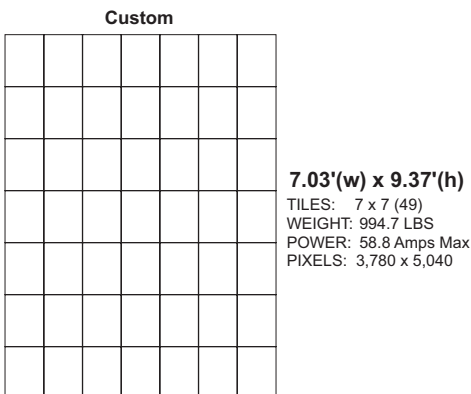
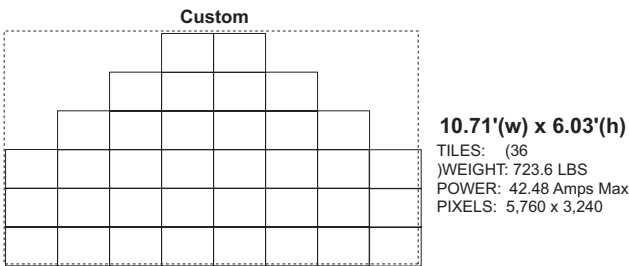
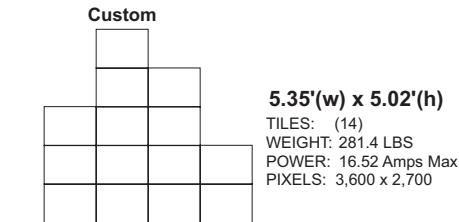
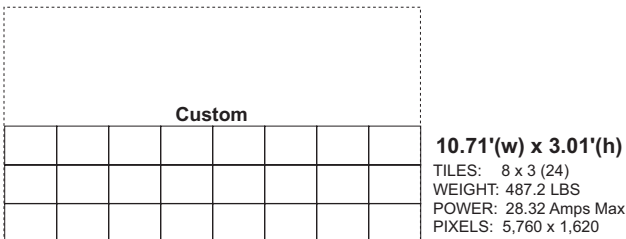
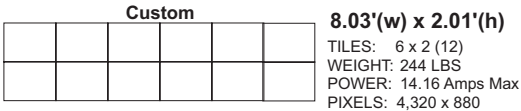

\*Ground Support feet on bottom row of MicroTiles will add approx. 1" to height of display

\*Other wall sizes available - Please call for custom wall configurations